

# COMO ELECTRIC FIREPLACE - NO HEAT

Model# :  EFCOM36  EFCOM45  EFCOM50  EFCOM60  
 EFCOM65  EFCOM72

## OWNER'S MANUAL

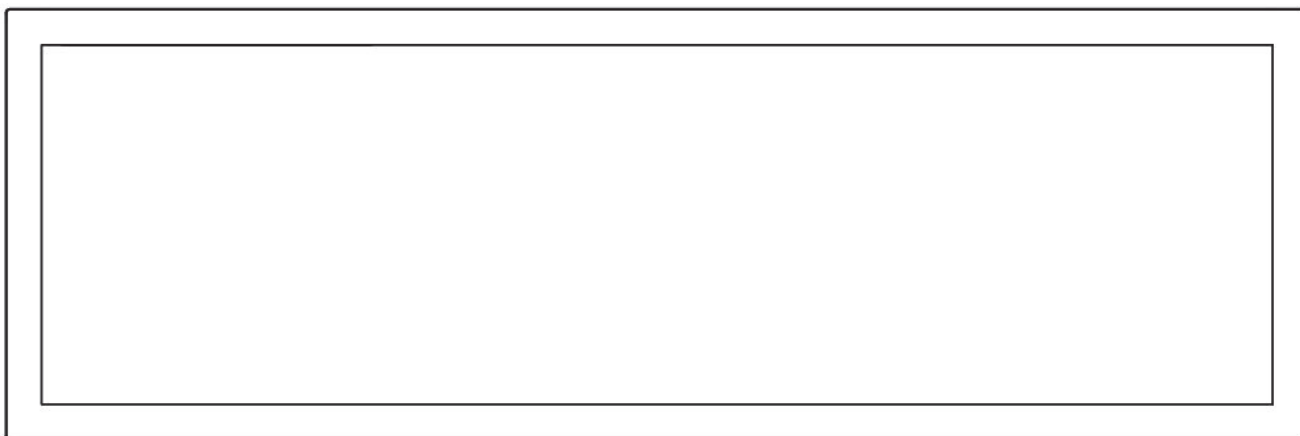

Slimline Wall Mounted / Built-in Electric Fireplace

**AC 220V-240V 50Hz**

 **WARNING**

**Read and understand** this entire owner's manual, including **all safety information**, before plugging in or **using** this product. Failure to do so could result in **fire, electric shock, or serious personal injury**.

# IMPORTANT SAFETY INFORMATION!

## WARNING

When using electrical appliances basic precautions should always be followed to reduce the risk of fire, electric shock and injury to persons, including the following:

- Read all instructions before using this fireplace.
- Always unplug fireplace when not in use.
- Do not operate any fireplace with a damaged cord or plug or after the fireplace malfunctions, has been dropped damaged in any manner, return fireplace to authorized service facility for examination, electrical or mechanical adjustment, or repair.
- Indoor use only, do not use outdoors.
- This fireplace is not intended for use in bathrooms, laundry areas and similar indoor locations. Never locate fireplace where it may fall into a bathtub or other water container.
- Do not run cord under carpeting. Do not cover cord with throw rugs, runners, or similar coverings. Arrange cord away from traffic area and where it will not be tipped over.
- To disconnect fireplace, turn controls to off, then remove plug from outlet.
- Use this fireplace only as describes in this manual. Any other use not recommended by the manufacturer may cause fire, electric shock, or injury to persons.
- Replacement of the lamps should be done only while the fireplace is disconnected from the supply circuit.
- This appliance is not intended for use by persons (including children) with reduced physical, sensory or capabilities, or lack of experience and knowledge, unless they have been given supervision or instruction concerning use of the appliance by a person responsible for their safety. Children should be supervised to ensure that they do not play with the appliance.

## Preparation









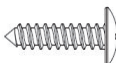

This product includes a **GLASS panel!** Always use **extreme caution** when handling **glass**. Failure to do so could result in **personal injury** or **property damage**.

Remove all parts and hardware from the carton and place them on a clean, soft, dry surface. Parts and assembly steps are grouped for wall-hanging or recessing use. Check the parts list to make sure nothing is missing. Dispose of packaging materials properly. Please recycle whenever possible.

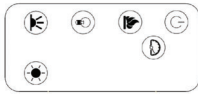
**You will need the following tools (not included):** Phillips screwdriver; stud finder; level; tape measure; electric drill; 1/4" wood drill bit, hammer.

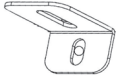
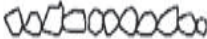
## Parts and Hardware

 <p><b>A – Fireplace</b></p>			
	<p><b>B – Wood Screws</b></p>		<p><b>C – Drywall anchors</b></p>
			
	<p>Remote Control</p>	<p>Plastic ember bed strip</p>	
			
<p><b>E-Wall Bracket</b> Fixed on back of firebox</p>	<p><b>F-L shape bracket</b></p>	<p><b>G-Decorative Crystals/Pebbles</b></p>	<p><b>H - Log set</b></p>

## Specification and Dimension

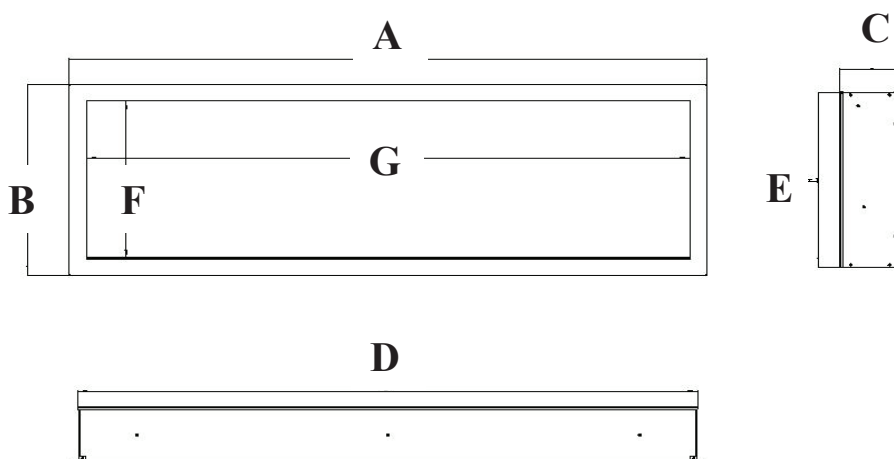

### PRODUCT DIMENSIONS

Model Number	A	B	C	D	E	F	G
EFCOM36	36" 91.5cm	16.54" 42cm	5.04" 12.8cm	34.53" 87.7cm	15.2" 38.6cm	13.78" 35cm	33.27" 84.5cm
EFCOM45	45" 114.3cm	16.54" 42cm	5.04" 12.8cm	43.51" 110.5cm	15.2" 38.6cm	13.78" 35cm	42.24" 107.3cm
EFCOM50	50" 127CM	16.54" 42cm	5.04" 12.8cm	48.51" 123.2cm	15.2" 38.6cm	13.78" 35cm	47.24" 120cm
EFCOM60	60" 152.4cm	16.54" 42cm	5.04" 12.8cm	58.51" 148.6cm	15.2" 38.6cm	13.78" 35cm	57.24" 145.4cm
EFCOM65	65" 165cm	16.54" 42cm	5.04" 12.8cm	63.51" 161.3cm	15.2" 38.6cm	13.78" 35cm	62.2" 158cm
EFCOM72	72" 182.8cm	16.54" 42cm	5.04" 12.8cm	70.52" 179.1cm	15.2" 38.6cm	13.78" 35cm	69.21" 175.8cm

# Installation and Assembly

## RECESSED TO WALL INSTALLATION

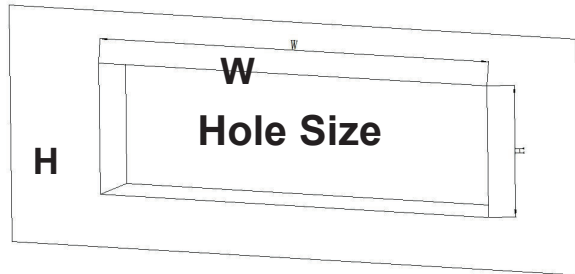

( A )

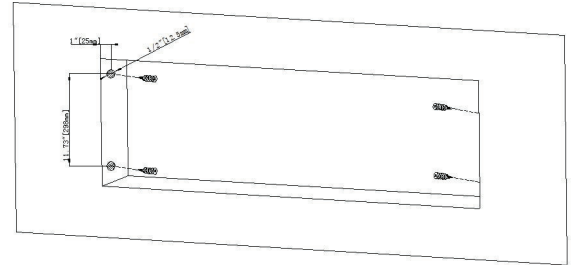

( B )

**STEP A.** Selection a dry wall to open a hole for fireplace box. Size of hole as below chart **Figure ( A )**

Framing Hole Size		
Model Number	W	H
EFCOM36	35.1" ( 89.2cm)	15.78" (40.1cm)
EFCOM45	44" ( 112cm)	15.78" (40.1cm)
EFCOM50	49" (124.46cm)	15.78" (40.1cm)
EFCOM60	59" (150.1cm)	15.78" (40.1cm)
EFCOM65	64" (162.8cm)	15.78" (40.1cm)
EFCOM72	71" (180.6cm)	15.78" (40.1cm)

**STEP B.** Fix the wall anchors in each side of the fireplace box according to the dimensions showed on the drawing. **Figure ( B )**

**NOTE:** The appliance tabs come bent. You must bend the tab flat by hand when fully recessing the appliance into the wall.

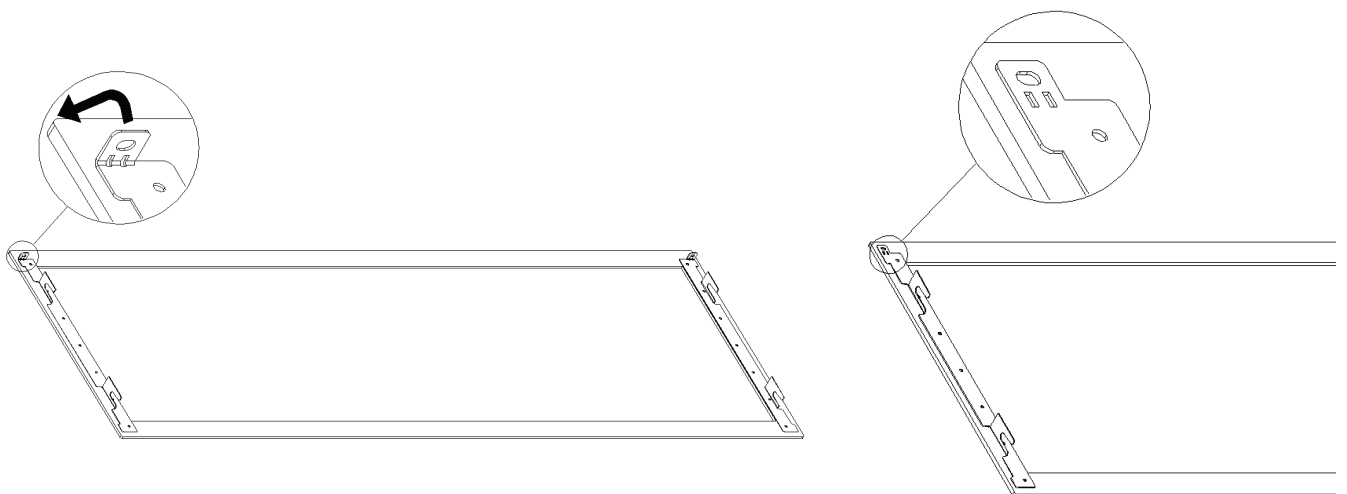

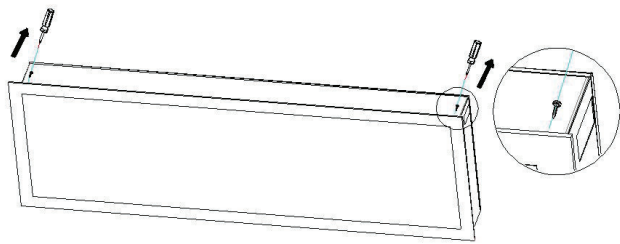

(C)

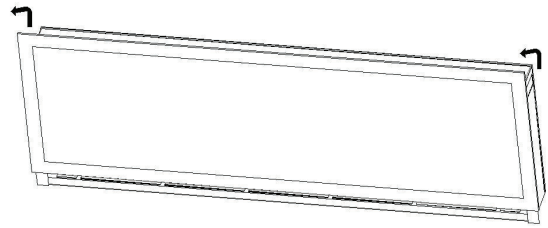

(D)

**STEP C.** Take off the screw in both sides of the top fireplace box. **Figure (C)**

**STEP D.** Have two person to take the glass panel out of the fireplace box. Place it to a soft and clean place. **Figure (D)**

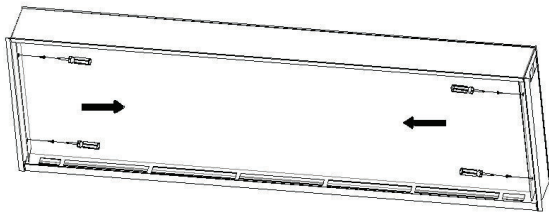

(E)

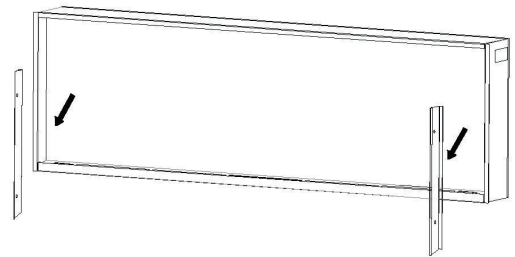

(F)

**STEP E.** Take off the two screws in both sides, then take off the two metal brackets, keep them well as you will need to screw back .have two people lift the fireplace and recessed it to the wall opening hole **Figure (E, F)**

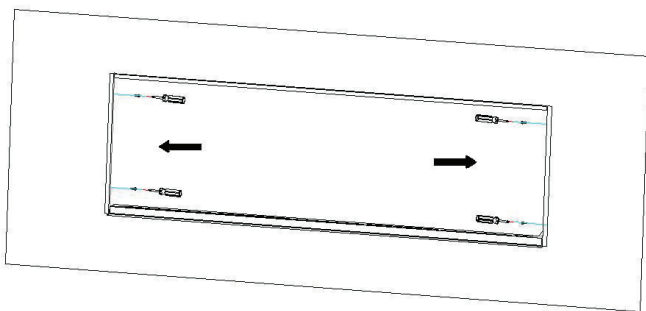

(G)

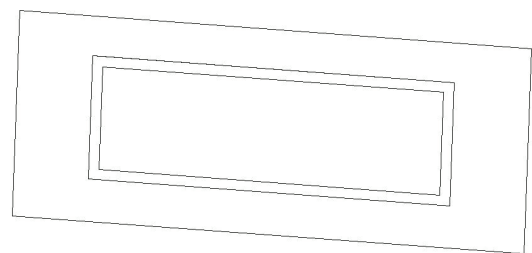

(H)

## Wall Mounted Installation

Due to the many different materials used on different walls, it is highly recommended that you consult your local builder before you install this appliance on the wall.

**A.** Select a location that is not prone to moisture and is located at least 36" (914mm) away from combustible materials such as curtain drapes, furniture, bedding, paper, etc.

**B.** Have two people hold the appliance against the wall to determine the final location.

**C.** Place unit face down on a soft, non abrasive surface. Remove the bracket from the back of the unit by removing the screws, refer to Figure 1.

**D.** Mark out location, then mount the bracket(s) onto the wall using the supplied screws. This bracket

MUST have the hooks facing upward and be level. **NOTE: It is strongly**

**recommended that the**

**mounting bracket (E) be**

**Screwed into the wall studs**

**Where possible. If the wall**

**Studs cannot be used, ensure**

**That the supplied plastic anchors are used to affix the bracket to the wall and the bracket is adequately secured.**

**E.** With the wall mounting bracket installed have two people lift the appliance up and insert the two hooks

on the bracket into the two slots on the back of the appliance.

**F.** Check the appliance for stability ensuring that the bracket will not pull free from the wall.

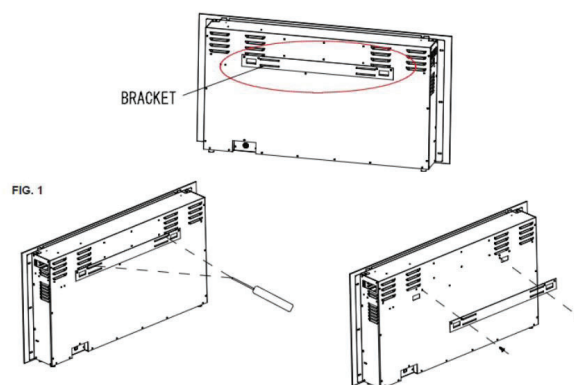
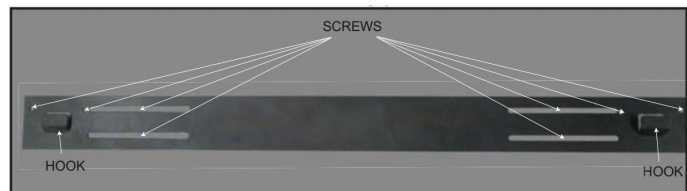

Wall Bracket Illustrated

# Log-set / Crystals/Pebbles Installation

(NOTE: Please make the installation according to the embers which you bought or selected.)

- A. Glass front must be removed and the appliance must be mounted in its final location before the drift logs embers are installed.
- B. Carefully place the plastic ember bed strip to the slot, then place crystal/pebbles embers onto the surface of the ember bed as illustrated. Apply an even layer from side to side. **Figure 1, Figure 2.**



**Figure 1.** (Crystals )



**Figure 2.** (Pebbles )

## Optional log-set installation

Carefully place log-set on the designed slot (see below illustration) (Figure 3.)



**Figure 3.** (Log-set)

# Operation



Read and understand this entire owner's manual, including **all safety information**, before **plugging in** or **using** this product. Failure to do so could result in **electric shock, fire, serious injury, or death.**

## Power

Plug the power cord into a AC 220-240 Volt outlet (see **IMPORTANT SAFETY INFORMATION** on **Pages 2 and 3**). Make sure the outlet is in good condition and that the plug is not loose. **NEVER** exceed the maximum amperage for the circuit. **DO NOT** plug other appliances into the same circuit.

## Methods of Operation

This electric fireplace can be operated **ONLY** by the REMOTE CONTROL.

Before operating, please review the **IMPORTANT SAFETY INFORMATION** on **Pages 2**, and heed all warnings.

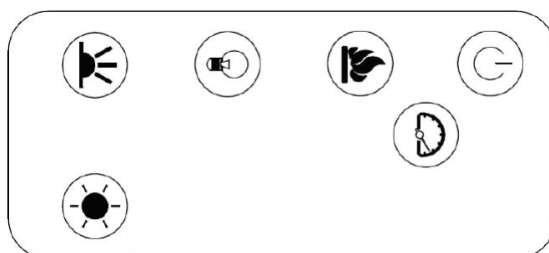





Remote Control

## Remote Control Operation

BUTTON	FUNCTION	ACTION & INDICATION
 <b>POWER</b>	<b>ON:</b> Enables control panel functions and remote control. Turns on flame effect. <b>OFF:</b> Disables control panel functions and remote control. Turns off flame effect.	<ol style="list-style-type: none"> <li><b>Press once.</b> Indicator light turns on. Power turns on. All functions enabled.</li> <li><b>Press again.</b> Flame effect turns off. Unit goes to standby. All functions turn off.</li> </ol>
 <b>SPEED</b>	<b>Flame speed button:</b> Controls the speed of the flame. There are 4 flame speed settings: 01 (slowest), 02 (Medium), 03 (fast), 04 (fastest)	<ol style="list-style-type: none"> <li><b>Press once.</b> Flame speed gets changing.</li> <li><b>Press again</b> until desired setting is reached. Display shows the setting.</li> </ol> <p>The Default setting is 02 (medium speed)</p>



 <b>FLAME COLOR</b>	<p><b>Flame color button:</b> Makes the color flame effect changing.</p> <p><b>NOTE:</b> color effect stays on until power button is turned off. Color flame effect must be on for fireplace to turn on.</p> <p><b>NOTE:</b> this fireplace is with memory function for flame.</p>	<ol style="list-style-type: none"> <li>1. <b>Press once.</b> Flame color effect gets changing.</li> <li>2. Press again until desired setting is reached. In total 3 colors for flame.</li> </ol>
 <b>FLAME BRIGHTNESS</b>	<p><b>FLAME button:</b> Makes flame effect dimmer and brighter.</p> <p><b>NOTE:</b> Flame effect stays on until power button is turned off. Flame effect must be on for heater to turn on.</p>	<ol style="list-style-type: none"> <li>1. <b>Press once.</b> Indicator light turns on. Flame brightness effect gets changing.</li> <li>2. <b>Press again.</b> until desired setting is reached.</li> </ol>
 <b>EMBER LIGHTS</b>	<p><b>LED Ember light button:</b> Makes the color on bottom effect gets changing.</p> <p><b>NOTE:</b> Ember color effect stays on until power button is turned off.</p> <p><b>NOTE:</b> this fireplace is with memory function for LED ember lights.</p>	<ol style="list-style-type: none"> <li>1. <b>Press once.</b> LED ember light color effect gets changing.</li> <li>2. <b>Press again</b> until desired setting is reached. In total 10 colors for EMBER.</li> <li>3. <b>Auto-cycle function:</b> When pressing with the <b>11<sup>th</sup></b> time, the LED ember light will do auto-cycling (<b>NOTE: It will take 15 seconds to switch between colors.</b>)</li> </ol>
 <b>EMBER BRIGHTNESS</b>	<p><b>LED Ember light brightness button:</b> Makes the LED ember lights on bottom effect gets changing.</p> <p><b>NOTE:</b> LED Ember light brightness effect stays on until power button is turned off.</p>	<ol style="list-style-type: none"> <li>1. <b>Press once.</b> LED ember light brightness effect gets changing.</li> <li>2. <b>Press again</b> until desired setting is reached. In total 5 levels.</li> </ol>

**NOTICE** To improve operation, **aim** the remote control at the front of the fireplace. **DO NOT press the buttons too quickly.** Give the unit time to respond to each command.

### Remote Control Battery Information

- Remote control uses one CR2025 battery (**Included**)

 **NEVER** dispose of batteries in **fire**. Failure to observe this precaution **may result in an explosion**. Dispose of batteries at your local hazardous material processing center.

# Care and Maintenance

## Cleaning



**ALWAYS** turn the fireplace **OFF** and **unplug the power cord from the outlet** before cleaning, performing maintenance, or moving this fireplace. Failure to do so could result in **electric shock, fire, or personal injury**.



**NEVER** immerse in water or **spray with water**. Doing so could result in **electric shock, fire, or personal injury**.

### Metal:

- Buff using a soft cloth, slightly dampened with a citrus oil-based product.
- **DO NOT** use brass polish or household cleaners as these products will damage the metal trim.

### Glass:

- Use a good quality glass cleaner sprayed onto the cloth or towel. Dry thoroughly with a paper towel or lint-free cloth.
- **NEVER** use abrasive cleansers, liquid sprays, or any cleaner that could scratch the surface.

### Vents:

- Use a vacuum or duster to remove dust and dirt from the fireplace and vent areas.

### Plastic:

- Wipe gently with a slightly damp cloth and a mild solution of dish soap and warm water.
- **NEVER** use abrasive cleansers, liquid sprays, or any cleaner that could scratch the surface.

## Maintenance



**Risk of electric shock! DO NOT OPEN any panels ! No user-serviceable parts inside!**



**ALWAYS** turn the fireplace **OFF** and **unplug the power cord from the outlet** before cleaning, performing maintenance, or moving this fireplace. Failure to do so could result in **electric shock, fire, or personal injury**.

### Electrical and Moving Parts:

- Electrical components are integrated in the fireplace and are not serviceable by the consumer.

### Storage:

- Store fireplace in a clean dry place when not in use.



**WARNING! NO SERVICING** of the internal or electrical parts should be performed by the consumer. Do not service the unit yourself.



**WEEE:**

**Meaning of crossed –out wheeled dustbin:**

Do not dispose of electrical appliances as unsorted municipal waste, use separate collection facilities. Contact you local government for information regarding the collection systems available. If electrical appliances are disposed of in landfills or dumps, hazardous substances can leak into the groundwater and get into the food chain, damaging your health and well-being.

When replacing old appliances with new ones, the retailer is legally obligated to take back your old appliance for disposals at least free of charge.