

HERMAN RECESSED ELECTRIC FIREPLACE

Model# : ■ EFBIF45 ■ EFBIF50 ■ EFBIF60 ■ EFBIF72

OWNER'S MANUAL



45"/50"/60"/72"-Built-in Electric Fireplace

AC 220-240V 50Hz 1400-1600W

⚠ WARNING

Read and understand this entire owner's manual, including **all safety information, before plugging in or using** this product. Failure to do so could result in **fire, electric shock, or serious personal injury.**

⚠ CAUTION

Keep this owner's manual for future reference. If you sell or give this product away, **make sure this manual accompanies this product.**

IMPORTANT SAFETY INFORMATION!

WARNING

When using electrical appliances basic precautions should always be followed to reduce the risk of fire, electric shock and injury to persons, including the following:

- Read all instructions before using this heater.
- This heater is hot when in use. To avoid burning, do not touch hot surface. If provided, use handles when moving this heater. Keep combustible materials, such as furniture, pillows, bedding, papers, clothes, and curtains at least 1 m from the front of the heater and keep them away from the sides and rear. In order to avoid overheating, do not cover the heater.
- Extreme caution is necessary when any heater is used near children or the infirm and whenever the heater is left operating and unattended.
- Always unplug heater when not in use.
- Do not operate any heater with a damaged cord or plug or after the heater malfunctions, has been dropped damaged in any manner, return heater to authorized service facility for examination, electrical or mechanical adjustment, or repair.
- Indoor use only, do not use outdoors.
- This heater is not intended for use in bathrooms, laundry areas and similar indoor locations. Never locate heater where it may fall into a bathtub or other water container.
- Do not run cord under carpeting. Do not cover cord with throw rugs, runners, or similar coverings. Arrange cord away from traffic area and where it will not be tipped over.
- To disconnect heater, turn controls to off, then remove plug from outlet.
- Do not inset or allow foreign objects to enter any ventilation or exhaust opening as this may cause an electric shock or fire, or damage the heater.
- To prevent a possible fire, do not block air intakes or exhaust in any manner. Do not use on soft surfaces, like a bed, where openings may become blocked.
- A heater has hot and arcing or sparking parts inside. Do not use it in areas where gasoline, or flammable liquids are used or stored.
- Use this heater only as describes in this manual. Any other use not recommended by the manufacturer may cause fire, electric shock, or injury to persons.
- DANGER-HIGH Temperatures may be generated under certain abnormal conditions. Do not partially or fully cover or obstruct the front of this heater.
- Replacement of the lamps should be done only while the heater is disconnected from the supply circuit.
- This appliance is not intended for use by persons (including children) with reduced physical, sensory or capabilities, or lack of experience and knowledge, unless they have been given supervision or instruction concerning use of the appliance by a person responsible for their safety. Children should be supervised to ensure that they do not play with the appliance.
- CAUTION: In order to avoid a hazard due to inadvertent resetting of the thermal cut-out, this appliance must not be supplied through an external switching device, such as a timer, or connected to a circuit that is regularly switched on and off by the utility.

Preparation







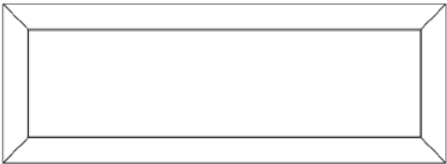

This product includes a **GLASS panel!** Always use **extreme caution** when handling **glass**. Failure to do so could result in **personal injury** or **property damage**.

Remove all parts and hardware from the carton and place them on a clean, soft, dry surface. Parts and assembly steps are grouped for free-standing or wall-hanging use. Check the parts list to make sure nothing is missing. Dispose of packaging materials properly. Please recycle whenever possible.

You will need the following tools (not included): Phillips screwdriver; stud finder; level; tape measure; electric drill; 1/4" wood drill bit, hammer.

Parts and Hardware

 <p>A – Fireplace</p>	 <p>B – Wood Screws</p>	 <p>C – Drywall anchors</p>
 <p>E - Drift Log Piece</p>	 <p>RC – Remote Control</p>	 <p>D- Crystals</p>
		 <p>F- Pebbles</p>

Installation and Assembly

MINIMUM CLEARANCE TO COMBUSTIBLES

Measurements are taken from the glass front.			
Bottom	0"	Top	11.8" (300mm) to mantel
Sides	0"	Top	11.8" (300mm) to ceiling
Back	0"		

STEP 1. Selection a dry wall to open a hole for fireplace box. Size of holes as below chart

Model No.	W	H	T
EFBIF45	43" (109.22cm)	16.8" (42.67cm)	6.7" (17cm)
EFBIF50	48" (121.92cm)	16.8" (42.67cm)	6.7" (17cm)
EFBIF60	58" (147.32cm)	16.8" (42.67cm)	6.7" (17cm)
EFBIF72	70" (177.8cm)	16.8" (42.67cm)	6.7" (17cm)

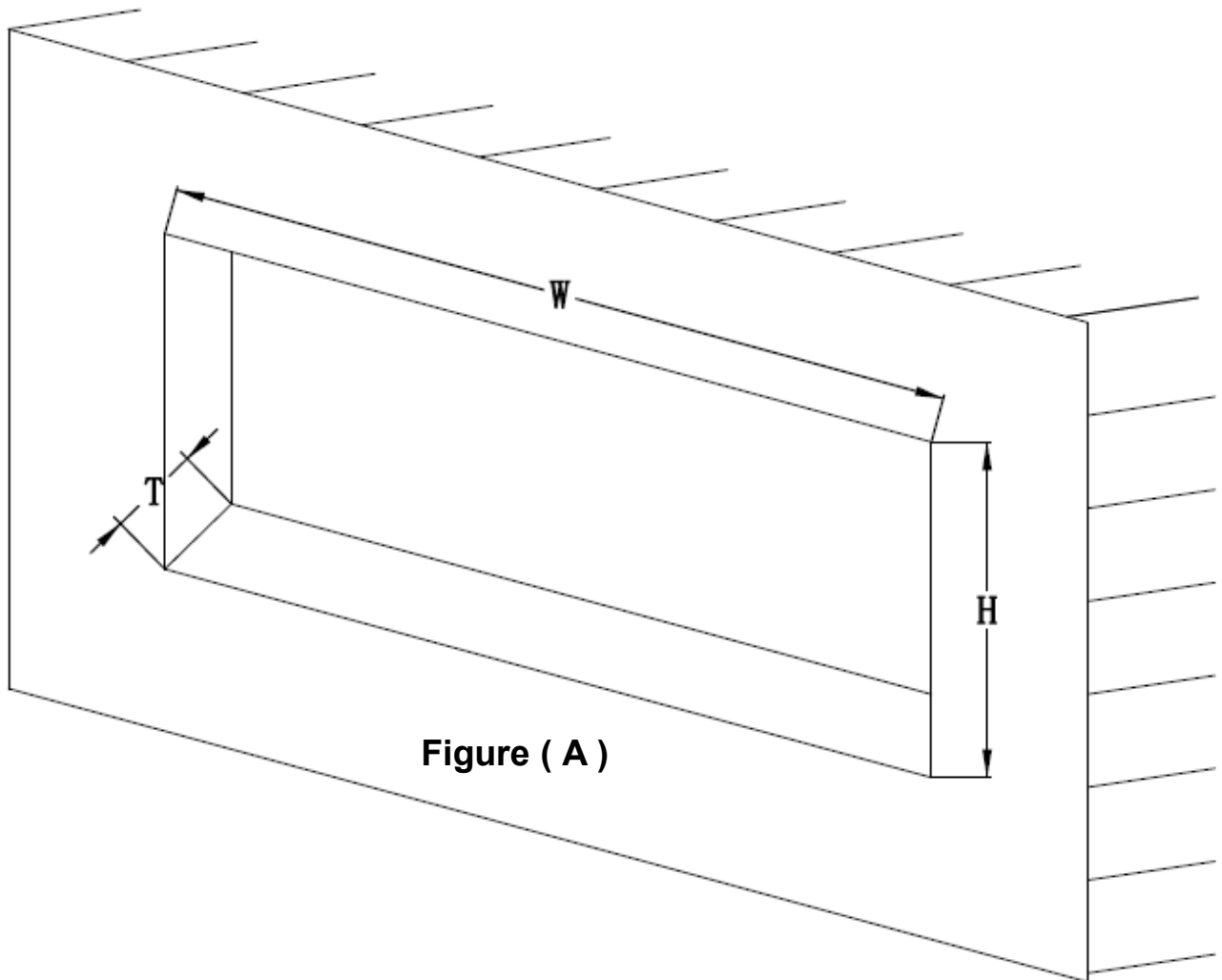

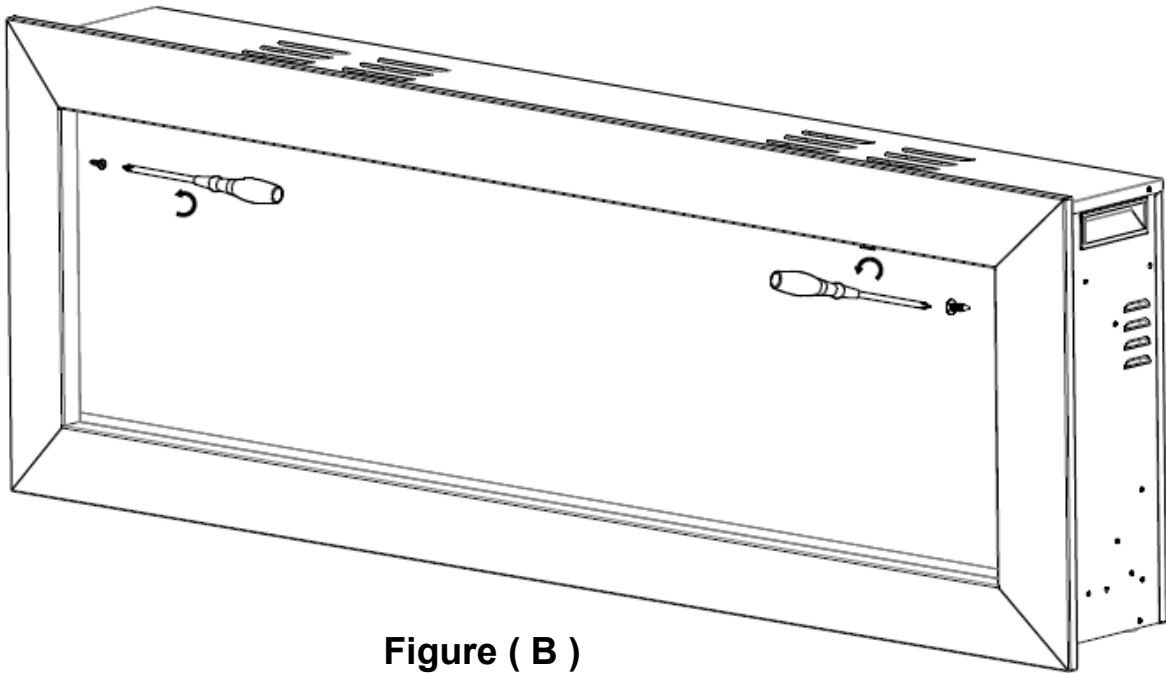

Figure (B)

STEP 2. Place the fireplace to a **soft clean place.** using the screw driver to take off the **TWO** screws in both sides. **Figure (B)**

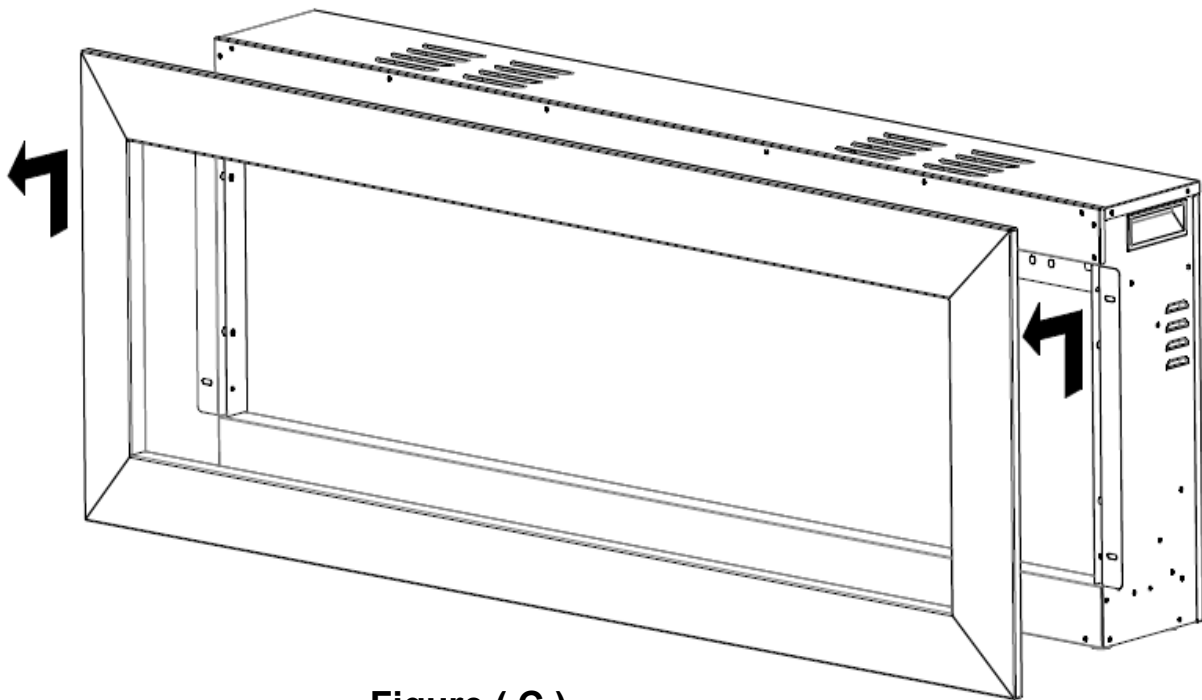

Figure (C)

STEP 3. Have two people to pull the trim up, then take them out of the fireplace box. **Figure (C)**

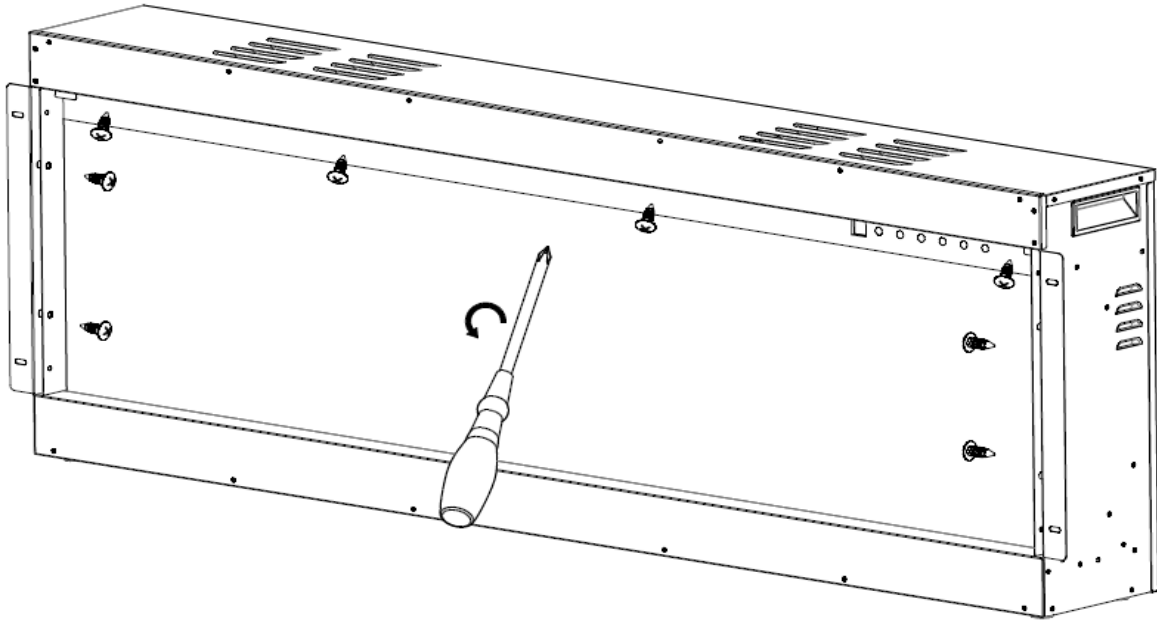
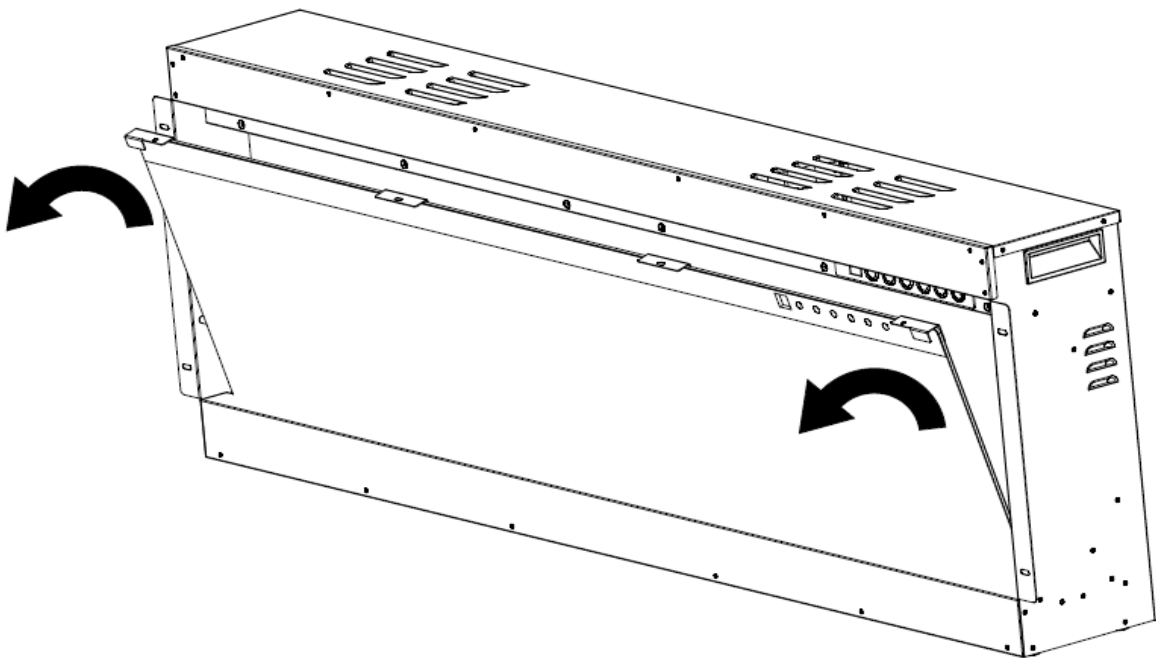

Figure (D)

STEP 4. Using the screw driver to take off the 8 screws as above **Figure (D)**, have two people to take out the glass panel **Figure (E)** and move it to a clean soft place to avoid the scratching.



STEP 5. Have two people to lift the fireplace box and put it into the opened hole. Fixing the FOUR wall screws in each side of the fireplace box. **Figure (F)**

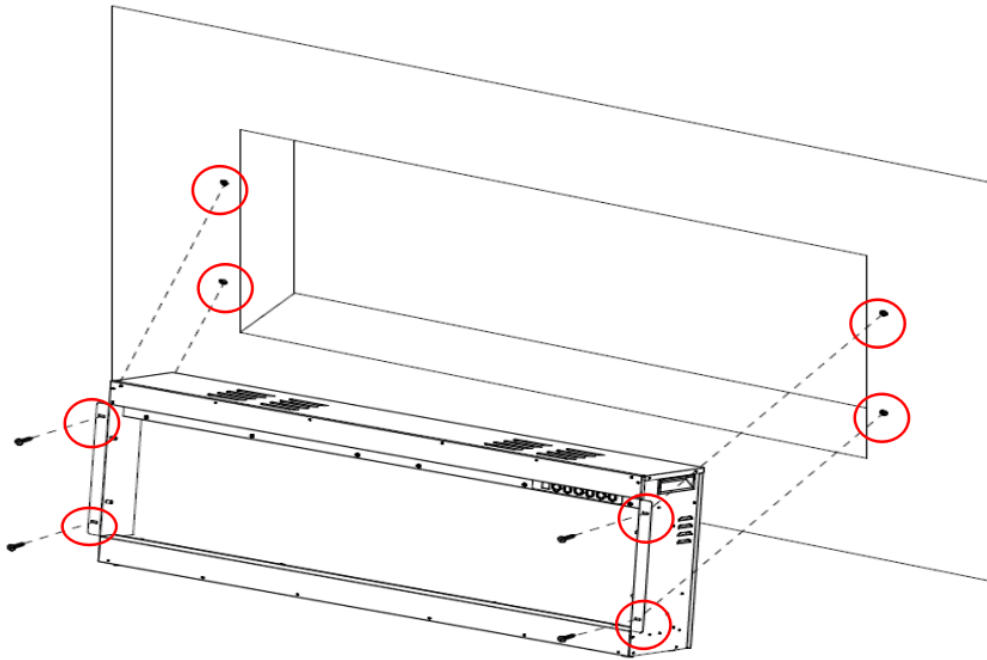

Figure (F)

STEP 6. Place the Decorative Crystals and Drift log pieces on the designed slot and even with them, **Figure (G)**

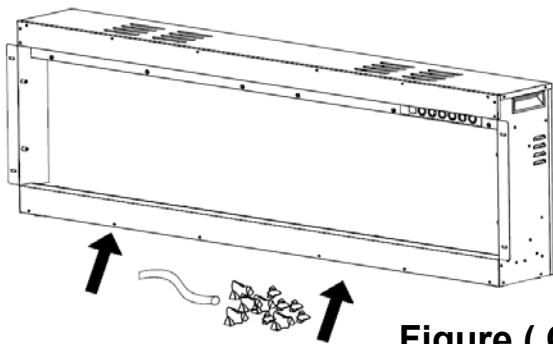

Figure (G)



STEP 7. After Placing the decorative crystals and Drift log pieces on the designed slot and even with them from side to side . Move and screw back the glass panel and metal trim.

(Repeat as **Fig B,C,D,E**)

HARD WIRING INSTALLATION

WARNING

TURN OFF THE APPLIANCE COMPLETELY AND LET COOL BEFORE SERVICING. ONLY A QUALIFIED SERVICE PERSON SHOULD SERVICE AND REPAIR THIS ELECTRIC APPLIANCE.

HARD WIRING CONNECTION

If it is necessary to hard wire this appliance, a qualified electrician must remove the cord connection, and wire the appliance directly to the house hold wiring.

This appliance must be electrically connected and grounded in accordance with local codes, if hard wired. In the absence of local codes, use the current CSA C22.1 CANADIAN ELECTRICAL CODE in Canada or the current ANSI/NFPA 70 NATIONAL ELECTRICAL CODE in the United States.

Fig. 1

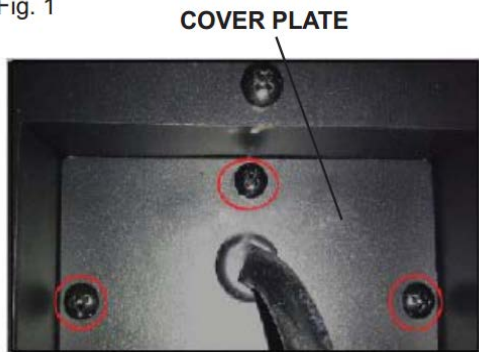
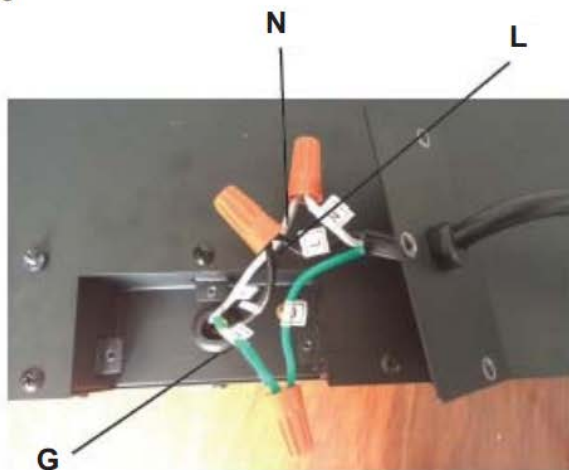

Fig. 2



- A. Remove the cover plate from the right side bottom of the appliance by removing the three screws, as shown above.
- B. Remove the wire connectors from the power cord. The power cord may be discarded.
- C. Take the new cover plate, supplied in the hardware bag. Punch out the 7/8" (22.2mm) hole and install a box connector through, into the junction box. Snap the box connector clamp onto the supply wires.
- D. Using the wire connectors, connect the ground green wires (G), the common white wires (N) together, then the hot black wires (L) and then the refer to Figure 3.
- E. Reinstall the cover plate using the three screws, as shown in Figure 1.

Fig. 3



Operation



Read and understand this entire owner's manual, including all safety information, before plugging in or using this product. Failure to do so could result in electric shock, fire, serious injury, or death.

Power

Plug the power cord into a 220-240 Volt 10 Amp grounded outlet (see **IMPORTANT SAFETY INFORMATION** on **Pages 2 and 3**). Make sure the outlet is in good condition and that the plug is not loose. **NEVER** exceed the maximum amperage for the circuit. **DO NOT** plug other appliances into the same circuit.

Methods of Operation

This electric fireplace can be operated by the TOUCH PANEL, located on the right side panel of the fireplace (see figure below), or by the battery-powered REMOTE CONTROL.





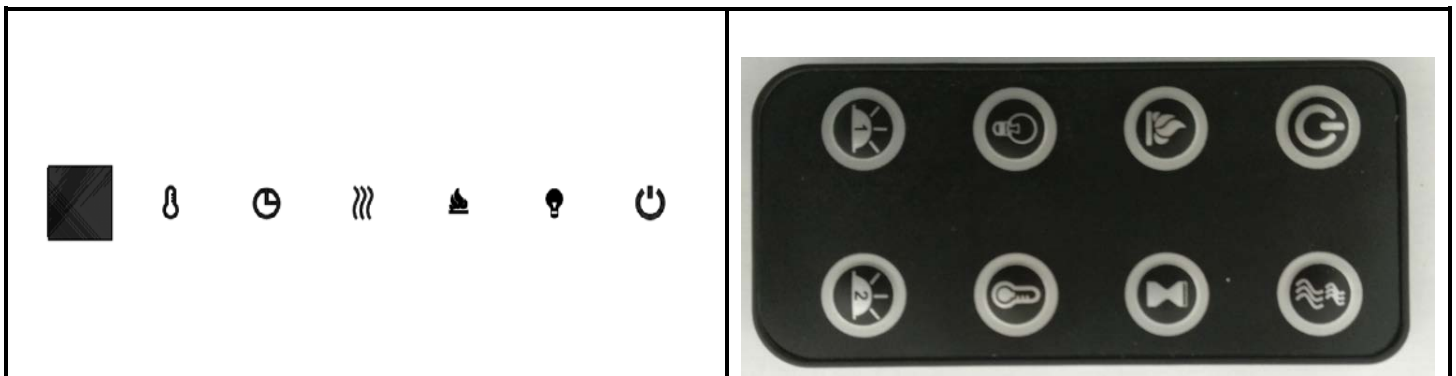

The operation and functions of the two methods are the same.



Before operating, please review the **IMPORTANT SAFETY INFORMATION** on **Pages 2 and 3**, and heed all warnings.



Touch Panel

Remote Control & Touch Panel Operation

BUTTON	FUNCTION	ACTION & INDICATION																																							
 POWER	<p>ON: Enables control panel functions and remote control. Turns on flame effect.</p> <p>OFF: Disables control panel functions and remote control. Turns off flame effect.</p>	<ol style="list-style-type: none"> Press once. Indicator light turns on. Power turns on. All functions enabled. Press again. Flame effect turns off. Unit goes to standby. All functions turn off. 																																							
 TIMER	<p>TIMER button: Controls timer settings to turn off fireplace at selected time.</p> <p>Settings range from 0.5 hours to 8 hours.</p>	<ol style="list-style-type: none"> Press once. Indicator light turns on. Timer is set to 0.5 hours. Press again until desired setting is reached. Indicator lights show setting. 																																							
 FLAME	<p>FLAME button: Makes flame effect dimmer and brighter.</p> <p>NOTE: Flame effect stays on until power button is turned off. Flame effect must be on for heater to turn on.</p>	<ol style="list-style-type: none"> Press once. Flame brightness effect gets changing. Press again. until desired setting is reached. 																																							
 COLOR	<p>COLOR button: Makes the color flame effect changing.</p> <p>NOTE: color effect stays on until power button is turned off. Color flame effect must be on for heater to turn on.</p> <p>NOTE: this fireplace is with memory function for flame.</p>	<ol style="list-style-type: none"> Press once. Flame color effect gets changing. Press again until desired setting is reached. 																																							
 HEATER	<p>HEATER button: Turns heater on and off.</p> <p>NOTE: The heater only works when the flame effect is on. If the flame effect is off, the heater will not turn on.</p> <p>NOTE: To prevent overheating, the heater fan will blow cool air for 8-10 seconds before the heater turns on, and after the heater turns off.</p>	<ol style="list-style-type: none"> Press once. Indicator lights up. Fan blows cool air for 10 seconds. 750W heater turns on and blows warm air. Press again. Indicator lights up. 1500W heater turns on and blows hot air. Press again. Heaters turn off. The fan blows cool air for 10 seconds to allow heater to cool down, then turns off. 																																							
 	<p>TEMPERATURE button: Turns heater on and off.</p> <p>NOTE: Press the button for 5 seconds, the temperature setting will switch from °C to °F. Same way from °F to °C.</p>	<ol style="list-style-type: none"> Press once: Touch panel indicator becomes active. Press again: until desired setting is Reached. Digital display shows setting circles as below: <table border="1" data-bbox="901 1785 1510 1879"> <thead> <tr> <th>Display</th> <th>0</th> <th>1</th> <th>2</th> <th>3</th> <th>4</th> <th>5</th> <th>6</th> <th>7</th> <th>8</th> <th>9</th> <th>10</th> <th>N</th> </tr> </thead> <tbody> <tr> <td>°C</td> <td>20</td> <td>21</td> <td>22</td> <td>23</td> <td>24</td> <td>25</td> <td>26</td> <td>27</td> <td>28</td> <td>29</td> <td>30</td> <td>C</td> </tr> <tr> <td>°F</td> <td>68</td> <td>70</td> <td>72</td> <td>74</td> <td>76</td> <td>78</td> <td>80</td> <td>82</td> <td>84</td> <td>86</td> <td>88</td> <td>F</td> </tr> </tbody> </table>	Display	0	1	2	3	4	5	6	7	8	9	10	N	°C	20	21	22	23	24	25	26	27	28	29	30	C	°F	68	70	72	74	76	78	80	82	84	86	88	F
Display	0	1	2	3	4	5	6	7	8	9	10	N																													
°C	20	21	22	23	24	25	26	27	28	29	30	C																													
°F	68	70	72	74	76	78	80	82	84	86	88	F																													

	<p>LED Ember light button (1): Makes the color on bottom effect changing.</p> <p>NOTE: Ember color effect stays on until power button is turned off.</p>	<p>1. Press once. Ember color effect gets changing.</p> <p>2. Press again. until desired setting is reached, in total 10 colors recycling.</p>
	<p>LED Bottom light button (2): Makes the color on bottom effect changing /flash changing automatically.</p> <p>NOTE: Ember color effect stays on until power button is turned off.</p>	<p>1. Press once. Ember color effect gets changing automatically.</p> <p>2. Press again. Ember color effect gets with flash changing automatically .</p>

NOTICE When the fireplace is first turned on, a slight odor may be present. This is normal and should not occur again unless the fireplace is not used for a long period of time.

NOTICE To improve operation, **aim** the remote control at the front of the fireplace. **DO NOT press the buttons too quickly.** Give the unit time to respond to each command.

Temperature Limiting Control

This heater is equipped with a Temperature Limiting Control. Should the heater reach an unsafe temperature, the heater will automatically turn OFF. To reset:

1. Unplug the power cord from the outlet.
2. Turn the ON/OFF switch on the CONTROL PANEL to OFF. **Wait 5 minutes.**
3. Inspect the fireplace to make sure no vents are blocked, or clogged with dust or lint. If they are, use a vacuum to clean the vent areas.
4. With the POWER switch in the OFF position, plug the power cord back into the outlet.
5. If the problem continues, have your outlet and wiring inspected by a professional.

Remote Control Battery Information

- This remote control uses CR2025 **battery (included).**
- Instructions for battery installation are on the Remote Control battery compartment.

 **NEVER** dispose of batteries in **fire**. Failure to observe this precaution **may result in an explosion**. Dispose of batteries at your local hazardous material processing center.

Care and Maintenance

Cleaning

 **ALWAYS** turn the fireplace **OFF** and **unplug the power cord from the outlet** before cleaning, performing maintenance, or moving this fireplace. Failure to do so could result in **electric shock, fire, or personal injury.**



NEVER immerse in water or spray with water. Doing so could result in **electric shock, fire, or personal injury.**

Metal:

- Buff using a soft cloth, slightly dampened with a citrus oil-based product.
- **DO NOT** use brass polish or household cleaners as these products will damage the metal trim.

Glass:

- Use a good quality glass cleaner sprayed onto the cloth or towel. Dry thoroughly with a paper towel or lint-free cloth.
- **NEVER** use abrasive cleansers, liquid sprays, or any cleaner that could scratch the surface.

Vents:

- Use a vacuum or duster to remove dust and dirt from the fireplace and vent areas.

Plastic:

- Wipe gently with a slightly damp cloth and a mild solution of dish soap and warm water.
- **NEVER** use abrasive cleansers, liquid sprays, or any cleaner that could scratch the surface.

Maintenance



Risk of electric shock! DO NOT OPEN any panels ! No user-serviceable parts inside!



ALWAYS turn the fireplace **OFF** and **unplug the power cord from the outlet** before cleaning, performing maintenance, or moving this fireplace. Failure to do so could result in **electric shock, fire, or personal injury.**

Electrical and Moving Parts:

- The fan motors are lubricated at the factory and will not require lubrication.
- Electrical components are integrated in the fireplace and are not serviceable by the consumer.

Storage:

- Store fireplace in a clean dry place when not in use.



WARNING! NO SERVICING of the internal or electrical parts should be performed by the consumer. Do not service the unit yourself.