

ELECTRIC INSERT FIREPLACE HEATER

OWNERS MANUAL

Model Numbers:EF-STAR30 (BEF-28BM13)



AC 220-240V 50Hz 1750-2000W

⚠ WARNING

Read and understand this entire owner's manual, including **all safety information**, before plugging in or **using** this product. Failure to do so could result in **fire, electric shock, or serious personal injury**.

⚠ CAUTION

Keep this owner's manual for future reference. If you sell or give this product away, **make sure this manual accompanies this product**.



IMPORTANT SAFETY INFORMATION!

WARNING

When using electrical appliances basic precautions should always be followed to reduce the risk of fire, electric shock and injury to persons, including the following:

- Read all instructions before using this heater.
- This heater is hot when in use. To avoid burning, do not touch hot surface. If provided, use handles when moving this heater. Keep combustible materials, such as furniture, pillows, bedding, papers, clothes, and curtains at least 1 m from the front of the heater and keep them away from the sides and rear. In order to avoid overheating, do not cover the heater.
- Extreme caution is necessary when any heater is used near children or the infirm and whenever the heater is left operating and unattended.
- Always unplug heater when not in use.
- Do not operate any heater with a damaged cord or plug or after the heater malfunctions, has been dropped damaged in any manner, return heater to authorized service facility for examination, electrical or mechanical adjustment, or repair.
- Indoor use only, do not use outdoors.
- This heater is not intended for use in bathrooms, laundry areas and similar indoor locations. Never locate heater where it may fall into a bathtub or other water container.
- Do not run cord under carpeting. Do not cover cord with throw rugs, runners, or similar coverings. Arrange cord away from traffic area and where it will not be tipped over.
- To disconnect heater, turn controls to off, then remove plug from outlet.
- Do not inset or allow foreign objects to enter any ventilation or exhaust opening as this may cause an electric shock or fire, or damage the heater.
- To prevent a possible fire, do not block air intakes or exhaust in any manner. Do not use on soft surfaces, like a bed, where openings may become blocked.
- A heater has hot and arcing or sparking parts inside. Do not use it in areas where gasoline, or flammable liquids are used or stored.
- Use this heater only as describes in this manual. Any other use not recommended by the manufacturer may cause fire, electric shock, or injury to persons.
- DANGER-HIGH Temperatures may be generated under certain abnormal conditions. Do not partially or fully cover or obstruct the front of this heater.
- Replacement of the lamps should be done only while the heater is disconnected from the supply circuit.
- This appliance is not intended for use by persons (including children) with reduced physical, sensory or capabilities, or lack of experience and knowledge, unless they have been given supervision or instruction concerning use of the appliance by a person responsible for their safety. Children should be supervised to ensure that they do not play with the appliance.
- CAUTION: In order to avoid a hazard due to inadvertent resetting of the thermal cut-out, this appliance must not be supplied through an external switching device, such as a timer, or connected to a circuit that is regularly switched on and off by the utility.

Preparation







This product includes a **GLASS panel!** Always use **extreme caution** when **using**. Failure to do so could result in **personal injury** or **property damage**.

Remove all parts and hardware from the carton and place them on a clean, soft, dry surface. Check the parts list to make sure nothing is missing. Dispose of packaging materials properly. Please recycle whenever possible.

You will need the following tools (not included): Phillips screwdriver.

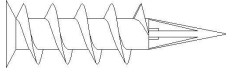
Parts and Hardware

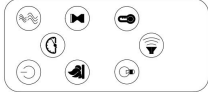
<p>A – Fireplace (1)</p> 			
	<p>B –Wood screws</p>	<p>C– Drywall anchors</p>	
			
	<p>D – Remote Control</p>		<p>Instruction Manual</p>

Wall Recessed Installation

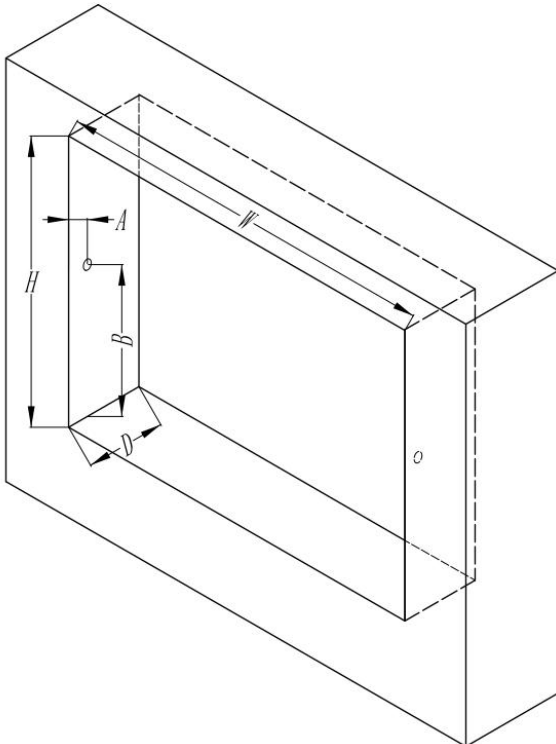

Model Number	Framing size (mm)			Screw Holes	
	W	H	D	A	B
EF-STAR30 (BEF-28BM13)	710	605	250	25	514

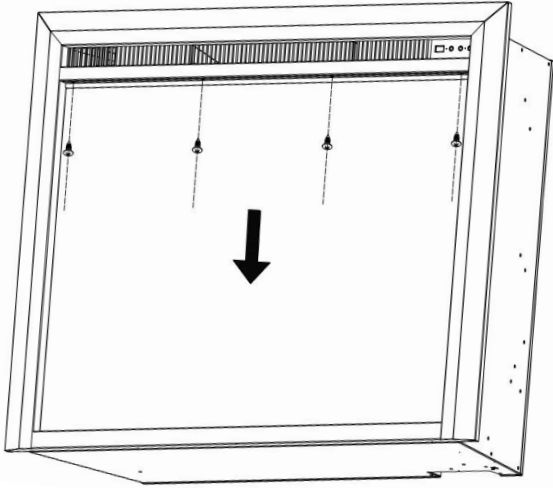

Fig. 6

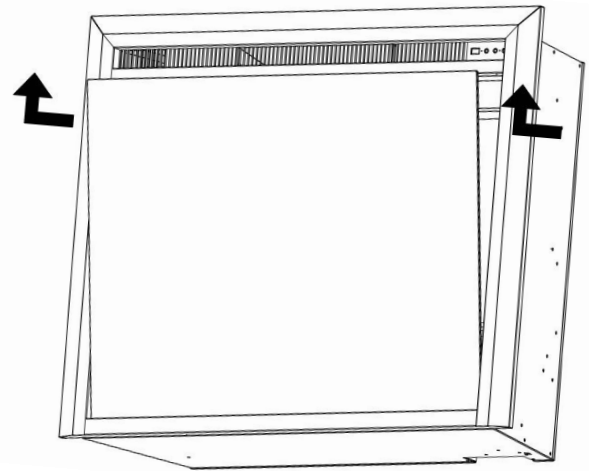

Fig. 7

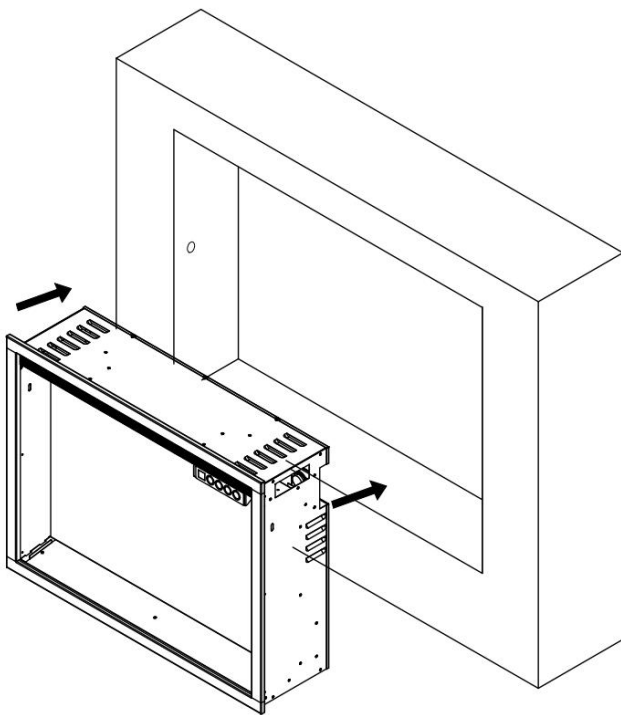

Fig. 8

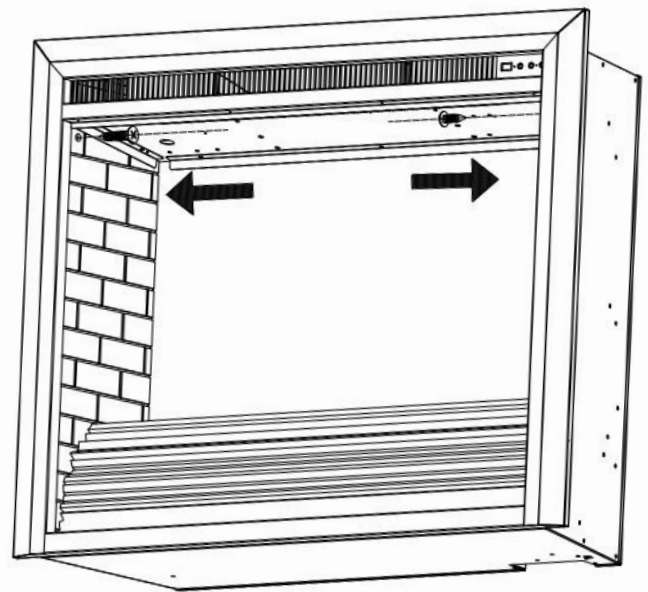

Fig. 9

- Use the screw driver to take off the four screws from the bracket, and move the glass panel out. (Fig.6, Fig.7)
- Have two people lift the fireplace up and Insert it into the opening hole. (Fig.8)
- Fixing it by two screw(s), one piece with each side. (Fig 9)
- Reinstall the front glass panel.

Operation



Read and understand this entire owner's manual, including **all safety information**, before **plugging in** or **using** this product. Failure to do so could result in **electric shock, fire, serious injury, or death.**

Power

Make sure the ON/OFF switch, located on the front, is in the OFF position. Plug the power cord into a 220-240 Volt 10 Amp grounded outlet (see **IMPORTANT SAFETY INFORMATION** on **Pages 2 and 3**). Make sure the outlet is in good condition and that the plug is not loose. **NEVER** exceed the maximum amperage for the circuit. **DO NOT** plug other appliances into the same circuit.

Methods of Operation

This electric fireplace can be operated by the CONTROL PANEL, located on the Front of the fireplace (see figure below), or by the battery-powered REMOTE CONTROL.

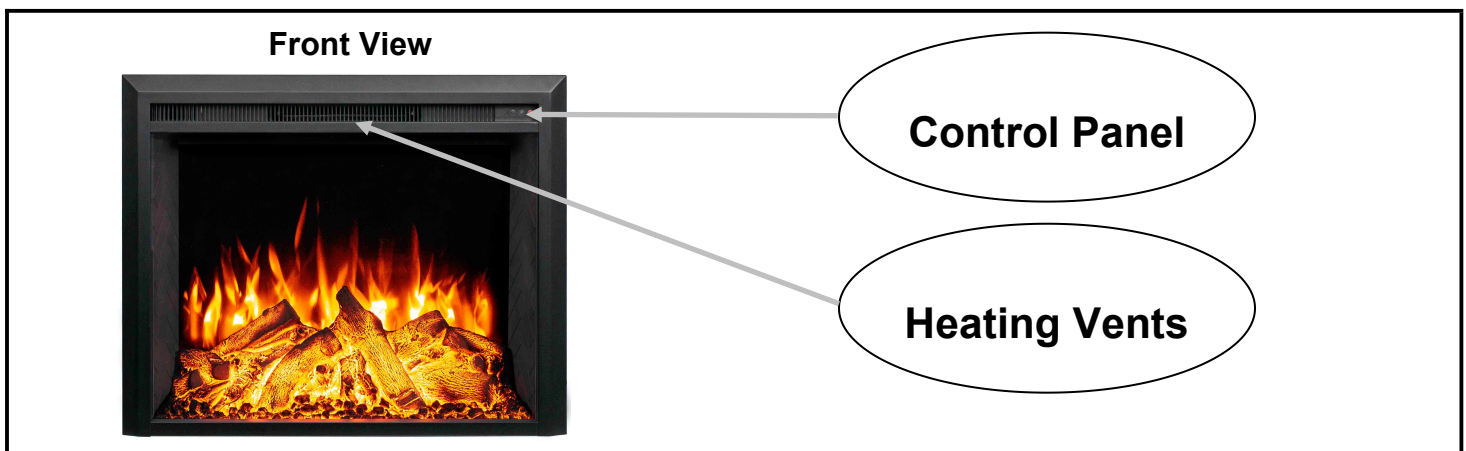

The operation and functions of the two methods are the same.

Before operating, please review the **IMPORTANT SAFETY INFORMATION** on **Pages 2 and 3**, and heed all warnings.





Control Panel Operation



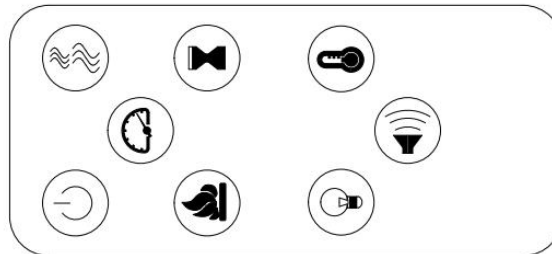

BUTTON	FUNCTION	ACTION & INDICATION
 POWER	<p>ON: Enables control panel functions and remote control. Turns on flame effect.</p> <p>OFF: Disables control panel functions and remote control. Turns off flame effect.</p>	<p>1. Press once. Indicator light turns on. Power turns on. All functions enabled.</p> <p>2. Press again. Flame effect turns off. Unit goes to standby. All functions turn off.</p>

 COLOR	<p>COLOR button: Makes the color flame effect changing.</p> <p>NOTE: color effect stays on until power button is turned off. Color flame effect must be on for heater to turn on.</p> <p>NOTE: this fireplace is with memory function for flame.</p>	<ol style="list-style-type: none"> 1. Press once. Flame color effect gets changing. 2. Press again until desired setting is reached. In total 3 colors.
 HEATER	<p>HEATER button: Turns heater on and off.</p> <p>NOTE: To prevent overheating, the heater fan will blow cool air for 8-10 seconds after the heater turns off.</p>	<ol style="list-style-type: none"> 1. Press once. Indicator lights up. Fan blows cool air for 10 seconds. 950W heater turns on and blows warm air. 2. Press again. Indicator lights up. 2000W heater turns on and blows hot air. 3. Press again. Heaters turn off. The fan blows cool air for 10 seconds to allow heater to cool down, then turns off.



Remote Control Operation

BUTTON	FUNCTION	ACTION & INDICATION
 POWER	<p>ON: Enables control panel functions and remote control. Turns on flame effect.</p> <p>OFF: Disables control panel functions and remote control. Turns off flame effect.</p>	<ol style="list-style-type: none"> 1. Press once. Indicator light turns on. Power turns on. All functions enabled. 2. Press again. Flame effect turns off. Unit goes to standby. All functions turn off.
 COLOR	<p>COLOR button: Makes the color flame effect changing.</p> <p>NOTE: color effect stays on until power button is turned off. Color flame effect must be on for heater to turn on.</p>	<ol style="list-style-type: none"> 3. Press once. Flame color effect gets changing. 4. Press again until desired setting is reached. In total 3 colors.
 FLAME	<p>FLAME button: Makes flame effect dimmer and brighter.</p> <p>NOTE: Flame effect stays on until power button is turned off. Flame effect must be on for heater to turn on.</p>	<ol style="list-style-type: none"> 1. Press once. Flame brightness effect gets changing. 2. Press again. until desired setting is reached.

 HEATER	<p>HEATER button: Turns heater on and off.</p> <p>NOTE: To prevent overheating, the heater fan will blow cool air for 8-10 seconds after the heater turns off.</p>	<ol style="list-style-type: none"> Press once. Indicator lights up. Fan blows cool air for 10 seconds. 950W heater turns on and blows warm air. Press again. Indicator lights up. 2000W heater turns on and blows hot air. Press again. Heaters turn off. The fan blows cool air for 10 seconds to allow heater to cool down, then turns off. 																																							
 SPEED	<p>Flame speed button: Makes the flame speed changing.</p> <p>NOTE: Flame speed effect stays on until power button is turned off.</p>	<ol style="list-style-type: none"> Press once. Indicator light turns on. flame speed effect gets changing. Press again. until desired setting is reached. <p>Cycle from 03-01-02-03-01-02-03 “03” is the default speed</p>																																							
 TEMP	<p>TEMPERATURE button: Turns heater on and off.</p> <p>NOTE: Press the button for 5 seconds, the temperature setting will switch from °C to °F. Same way from °F to °C.</p>	<ol style="list-style-type: none"> Press once: Touch panel indicator becomes active. Press again: until desired setting is Reached. Digital display shows setting circles as below: <table border="1" data-bbox="906 999 1515 1087"> <thead> <tr> <th>Display</th> <th>0</th> <th>1</th> <th>2</th> <th>3</th> <th>4</th> <th>5</th> <th>6</th> <th>7</th> <th>8</th> <th>9</th> <th>10</th> <th>N</th> </tr> </thead> <tbody> <tr> <td>°C</td> <td>20</td> <td>21</td> <td>22</td> <td>23</td> <td>24</td> <td>25</td> <td>26</td> <td>27</td> <td>28</td> <td>29</td> <td>30</td> <td>C</td> </tr> <tr> <td>°F</td> <td>68</td> <td>70</td> <td>72</td> <td>74</td> <td>76</td> <td>78</td> <td>80</td> <td>82</td> <td>84</td> <td>86</td> <td>88</td> <td>F</td> </tr> </tbody> </table>	Display	0	1	2	3	4	5	6	7	8	9	10	N	°C	20	21	22	23	24	25	26	27	28	29	30	C	°F	68	70	72	74	76	78	80	82	84	86	88	F
Display	0	1	2	3	4	5	6	7	8	9	10	N																													
°C	20	21	22	23	24	25	26	27	28	29	30	C																													
°F	68	70	72	74	76	78	80	82	84	86	88	F																													
 TIMER	<p>TIMER button: Controls timer settings to turn off fireplace at selected time.</p> <p>Settings range from 0.5 hours to 8 hours.</p>	<ol style="list-style-type: none"> Press once. Indicator light turns on. Timer is set to 0.5 hours. Press again until desired setting is reached. Indicator lights show setting. 																																							
 CRACKER	<p>Fire cracker button: Controls the sound of the firecracker. There are 3 settings: (High) - (Low) - (Off).</p> <p>NOTE: Default setting is High when turned on.</p>	<ol style="list-style-type: none"> Press once. Fire cracker goes to Lower sound. Press again. Fire cracker goes off 																																							

NOTICE When the heater is first turned on, a slight odor may be present. This is normal and should not occur again unless the heater is not used for a long period of time.

NOTICE To improve operation, **aim** the remote control at the front of the fireplace. **DO NOT press the buttons too quickly.** Give the unit time to respond to each command.

Temperature Limiting Control

This heater is equipped with a Temperature Limiting Control. Should the heater reach an unsafe temperature, the heater will automatically turn OFF. To reset:

1. Unplug the power cord from the outlet.
2. Turn the ON/OFF switch on the CONTROL PANEL to OFF. **Wait 5 minutes.**
3. Inspect the fireplace to make sure no vents are blocked, or clogged with dust or lint. If they are, use a vacuum to clean the vent areas.
4. With the POWER switch in the OFF position, plug the power cord back into the outlet.
5. If the problem continues, have your outlet and wiring inspected by a professional.

Remote Control Battery Information

- This remote control uses two ONE CR2025 battery (**included**).



NEVER dispose of batteries in **fire**. Failure to observe this precaution **may result in an explosion**. Dispose of batteries at your local hazardous material processing center.

Care and Maintenance

Cleaning



ALWAYS turn the heater **OFF** and **unplug the power cord from the outlet** before cleaning, performing maintenance, or moving this fireplace. Failure to do so could result in **electric shock, fire, or personal injury**.



NEVER immerse in water or **spray with water**. Doing so could result in **electric shock, fire, or personal injury**.

Metal:

- Buff using a soft cloth, slightly dampened with a citrus oil-based product.
- **DO NOT** use brass polish or household cleaners as these products will damage the metal trim.

Glass:

- Use a good quality glass cleaner sprayed onto the cloth or towel. Dry thoroughly with a paper towel or lint-free cloth.
- **NEVER** use abrasive cleansers, liquid sprays, or any cleaner that could scratch the surface.

Vents:

- Use a vacuum or duster to remove dust and dirt from the heater and vent areas.

Plastic:

- Wipe gently with a slightly damp cloth and a mild solution of dish soap and warm water.
- **NEVER** use abrasive cleansers, liquid sprays, or any cleaner that could scratch the surface.

Maintenance



Risk of electric shock! DO NOT OPEN any panels. No user-serviceable parts inside!



ALWAYS turn the heater **OFF** and **unplug the power cord from the outlet** before cleaning, performing maintenance, or moving this fireplace. Failure to do so could result in **electric shock, fire, or personal injury.**

Electrical and Moving Parts:

- The fan motors are lubricated at the factory and will not require lubrication.
- Electrical components are integrated in the fireplace and are not serviceable by the consumer.
- **Storage:**
- Store heater in a clean dry place when not in use.



WEEE: Meaning of crossed –out wheeled dustbin:

Do not dispose of electrical appliances as unsorted municipal waste, use separate collection facilities. Contact you local government for information regarding the collection systems available. If electrical appliances are disposed of in landfills or dumps, hazardous substances can leak into the groundwater and get into the food chain, damaging your health and well-being.

When replacing old appliances with new ones, the retailer is legally obligated to take back your old appliance for disposals at least free of charge.