

# 24-In 3-Sided Freestanding Electric Stove

## Model # EF-CON24

### OWNER'S MANUAL



**AC 220-240V 50Hz 1400-1600W**

**⚠ WARNING**

**Read and understand** this entire owner's manual, including **all safety information**, before **plugging in** or **using** this product. Failure to do so could result in **fire, electric shock, or serious personal injury.**

**⚠ CAUTION**

**Keep this owner's manual** for future reference. If you sell or give this product away, **make sure this manual accompanies this product.**

# IMPORTANT SAFETY INFORMATION!

## WARNING

**When using electrical appliances basic precautions should always be followed to reduce the risk of fire, electric shock and injury to persons, including the following:**

- Read all instructions before using this heater.
- This heater is hot when in use. To avoid burning, do not touch hot surface. If provided, use handles when moving this heater. Keep combustible materials, such as furniture, pillows, bedding, papers, clothes, and curtains at least 1 m from the front of the heater and keep them away from the sides and rear. In order to avoid overheating, do not cover the heater.
- Extreme caution is necessary when any heater is used near children or the infirm and whenever the heater is left operating and unattended.
- Always unplug heater when not in use.
- Do not operate any heater with a damaged cord or plug or after the heater malfunctions, has been dropped damaged in any manner, return heater to authorized service facility for examination, electrical or mechanical adjustment, or repair.
- Indoor use only, do not use outdoors.
- This heater is not intended for use in bathrooms, laundry areas and similar indoor locations. Never locate heater where it may fall into a bathtub or other water container.
- Do not run cord under carpeting. Do not cover cord with throw rugs, runners, or similar coverings. Arrange cord away from traffic area and where it will not be tipped over.
- To disconnect heater, turn controls to off, then remove plug from outlet.
- Do not inset or allow foreign objects to enter any ventilation or exhaust opening as this may cause an electric shock or fire, or damage the heater.
- To prevent a possible fire, do not block air intakes or exhaust in any manner. Do not use on soft surfaces, like a bed, where openings may become blocked.
- A heater has hot and arcing or sparking parts inside. Do not use it in areas where gasoline, or flammable liquids are used or stored.
- Use this heater only as describes in this manual. Any other use not recommended by the manufacturer may cause fire, electric shock, or injury to persons.
- DANGER-HIGH Temperatures may be generated under certain abnormal conditions. Do not partially or fully cover or obstruct the front of this heater.
- Replacement of the lamps should be done only while the heater is disconnected from the supply circuit.
- This appliance is not intended for use by persons (including children) with reduced physical, sensory or capabilities, or lack of experience and knowledge, unless they have been given supervision or instruction concerning use of the appliance by a person responsible for their safety. Children should be supervised to ensure that they do not play with the appliance.
- CAUTION: In order to avoid a hazard due to inadvertent resetting of the thermal cut-out, this appliance must not be supplied through an external switching device, such as a timer, or connected to a circuit that is regularly switched on and off by the utility.

## Preparation



This product includes a **GLASS panel!** Always use **extreme caution** when **using**. Failure to do so could result in **personal injury** or **property damage**.

Remove all parts and hardware from the carton and place them on a clean, soft, dry surface. Check the parts list to make sure nothing is missing. Dispose of packaging materials properly. Please recycle whenever possible.

## Parts and Hardware



A – Fireplace ( 1 )



B – Remote Control ( 1 )

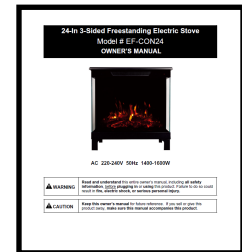

C- Instruction Manual (1)

## Operation



**Read and understand** this entire owner's manual, including **all safety information**, **before plugging in** or **using** this product. Failure to do so could result in **electric shock**, **fire**, **serious injury**, or **death**.

### Power

Plug the power cord into a 220-240 Volt 15 Amp grounded outlet (see **IMPORTANT SAFETY INFORMATION** on **Page 2**). Make sure the outlet is in good condition and that the plug is not loose. **NEVER** exceed the maximum amperage for the circuit. **DO NOT** plug other appliances into the same circuit.

### Methods of Operation

This electric fireplace can be operated by the CONTROL BUTTONS, located on the Front of the fireplace (see figure below), or by the battery-powered REMOTE CONTROL.

Before operating, please review the **IMPORTANT SAFETY INFORMATION** on **Page 2**, and heed all warnings.











**TOUCH PANEL**



**REMOTE CONTROL**

## REMOTE CONTROL / TOUCH PANEL OPERATION

BUTTON	FUNCTION	ACTION & INDICATION
 <b>POWER</b>	<p><b>ON:</b> Enables control panel functions and remote control. Turns on flame effect.</p> <p><b>OFF:</b> Disables control panel functions and remote control. Turns off flame effect.</p>	<ol style="list-style-type: none"> <li><b>Press once.</b> Indicator light turns on. Power turns on. All functions enabled.</li> <li><b>Press again.</b> Flame effect turns off. Unit goes to standby. All functions turn off.</li> </ol>
 <b>TIMER</b>	<p><b>TIMER button:</b> Controls timer settings to turn off fireplace at selected time. Settings range from 0.5 hours to 8 hours.</p>	<ol style="list-style-type: none"> <li><b>Press once.</b> Indicator light turns on. Timer is set to 0.5 hours.</li> <li><b>Press again until desired setting is reached.</b> Indicator lights show setting.</li> </ol>
 <b>FLAME</b>	<p><b>FLAME button:</b> Makes flame effect dimmer and brighter.</p> <p><b>NOTE:</b> Flame effect stays on until power button is turned off. Flame effect must be on for fireplace to turn on.</p>	<ol style="list-style-type: none"> <li><b>Press once.</b> Flame brightness effect starts changing.</li> <li><b>Press again</b> until desired setting is reached.</li> </ol>
 <b>COLOR</b>	<p><b>COLOR button:</b> Makes the flame effect change colors.</p> <p><b>NOTE:</b> Color effect stays on until power button is turned off. Color flame effect must be on for fireplace to turn on.</p>	<ol style="list-style-type: none"> <li><b>Press once.</b> Flame color effect starts changing.</li> <li><b>Press again</b> until desired setting is reached. There is a total of 6 flame colors.</li> </ol>
 <b>HEATER</b>	<p><b>HEATER button:</b> Turns heater on and off.</p> <p><b>NOTE:</b> The heater only works when the flame effect is on. If the flame effect is off, the heater will not turn on.</p> <p><b>Lock / Unlock the heater by pressing &amp; holding the button for 5 seconds. Display shows "LO."</b> <b>NOTE:</b> To prevent overheating, the heater blows cool air for 10 seconds.</p>	
 <b>SPEED</b>	<p><b>Flame speed button:</b> Controls the speed of the flame. There are 3 flame speed settings: 01 (slow), 02 (medium), and 03 (fast).</p>	<ol style="list-style-type: none"> <li><b>Press once.</b> Flame speed starts changing.</li> <li><b>Press again</b> until desired setting is reached. Display shows the setting.</li> </ol> <p>The default setting is 03 (fast).</p>

BUTTON	FUNCTION	ACTION & INDICATION																																															
 <b>CRACKLER</b>	<b>CRACKLING SOUND button:</b> Adjusts crackling sound.	1. <b>Press once.</b> Crackling sound is enabled. 2. <b>Press again</b> until desired setting is reached. <b>S2-S1-S0 (OFF)</b>																																															
 <b>TEMP</b>	<b>Temperature button:</b> Changes the temperature settings. 1. <b>Press once.</b> Touch panel indicator becomes active. 2. <b>Press again</b> until desired setting is reached. Digital display shows setting as below. <table border="1" data-bbox="284 525 1518 655"> <thead> <tr> <th>Display Value</th> <th>NO</th> <th>0</th> <th>1</th> <th>2</th> <th>3</th> <th>4</th> <th>5</th> <th>6</th> <th>7</th> <th>8</th> <th>9</th> <th>10</th> <th>11</th> <th>12</th> <th>NO</th> </tr> </thead> <tbody> <tr> <td rowspan="2">Temperature</td> <td>C°</td> <td>18</td> <td>19</td> <td>20</td> <td>21</td> <td>22</td> <td>23</td> <td>24</td> <td>25</td> <td>26</td> <td>27</td> <td>28</td> <td>29</td> <td>30</td> <td>C°</td> </tr> <tr> <td>F°</td> <td>64</td> <td>66</td> <td>68</td> <td>70</td> <td>72</td> <td>74</td> <td>76</td> <td>78</td> <td>80</td> <td>82</td> <td>84</td> <td>86</td> <td>88</td> <td>F°</td> </tr> </tbody> </table>	Display Value	NO	0	1	2	3	4	5	6	7	8	9	10	11	12	NO	Temperature	C°	18	19	20	21	22	23	24	25	26	27	28	29	30	C°	F°	64	66	68	70	72	74	76	78	80	82	84	86	88	F°	<b>NOTE:</b> Press the button for 5 seconds to switch between °C and °F
Display Value	NO	0	1	2	3	4	5	6	7	8	9	10	11	12	NO																																		
Temperature	C°	18	19	20	21	22	23	24	25	26	27	28	29	30	C°																																		
	F°	64	66	68	70	72	74	76	78	80	82	84	86	88	F°																																		

**NOTICE** When the heater is first turned on, a slight odor may be present. This is normal and should not occur again unless the heater is not used for a long period of time.

**NOTICE** To improve operation, **aim** the remote control at the front of the fireplace. **DO NOT press the buttons too quickly.** Give the unit time to respond to each command.

## Temperature Limiting Control

This heater is equipped with a Temperature Limiting Control. Should the heater reach an unsafe temperature, the heater will automatically turn OFF. To reset:

1. Unplug the power cord from the outlet.
2. Turn the ON/OFF switch on the CONTROL PANEL to OFF. **Wait 5 minutes.**
3. Inspect the fireplace to make sure no vents are blocked, or clogged with dust or lint. If they are, use a vacuum to clean the vent areas.
4. With the POWER switch in the OFF position, plug the power cord back into the outlet.
5. If the problem continues, have your outlet and wiring inspected by a professional.

## Remote Control Battery Information

- This remote control uses **TWO AAA batteries ( Not included).**

 **NEVER** dispose of batteries in **fire**. Failure to observe this precaution **may result in an explosion**. Dispose of batteries at your local hazardous material processing center.

# Care and Maintenance

## Cleaning



**ALWAYS** turn the heater **OFF** and **unplug the power cord from the outlet** before cleaning, performing maintenance, or moving this fireplace. Failure to do so could result in **electric shock, fire, or personal injury**.



**NEVER** immerse in water or **spray with water**. Doing so could result in **electric shock, fire, or personal injury**.

### Metal:

- Buff using a soft cloth, slightly dampened with a citrus oil-based product.
- **DO NOT** use brass polish or household cleaners as these products will damage the metal trim.

### Glass:

- Use a good quality glass cleaner sprayed onto the cloth or towel. Dry thoroughly with a paper towel or lint-free cloth.
- **NEVER** use abrasive cleansers, liquid sprays, or any cleaner that could scratch the surface.

### Vents:

- Use a vacuum or duster to remove dust and dirt from the heater and vent areas.

### Plastic:

- Wipe gently with a slightly damp cloth and a mild solution of dish soap and warm water.
- **NEVER** use abrasive cleansers, liquid sprays, or any cleaner that could scratch the surface.

## Maintenance



**Risk of electric shock! DO NOT OPEN any panels. No user-serviceable parts inside!**



**ALWAYS** turn the heater **OFF** and **unplug the power cord from the outlet** before cleaning, performing maintenance, or moving this fireplace. Failure to do so could result in **electric shock, fire, or personal injury**.

### Electrical and Moving Parts:

- The fan motors are lubricated at the factory and will not require lubrication.
- Electrical components are integrated in the fireplace and are not serviceable by the consumer.

### Storage:

- Store heater in a clean dry place when not in use.

# CONRAD BASE

for 3-Sided Electric Fireplace Stove

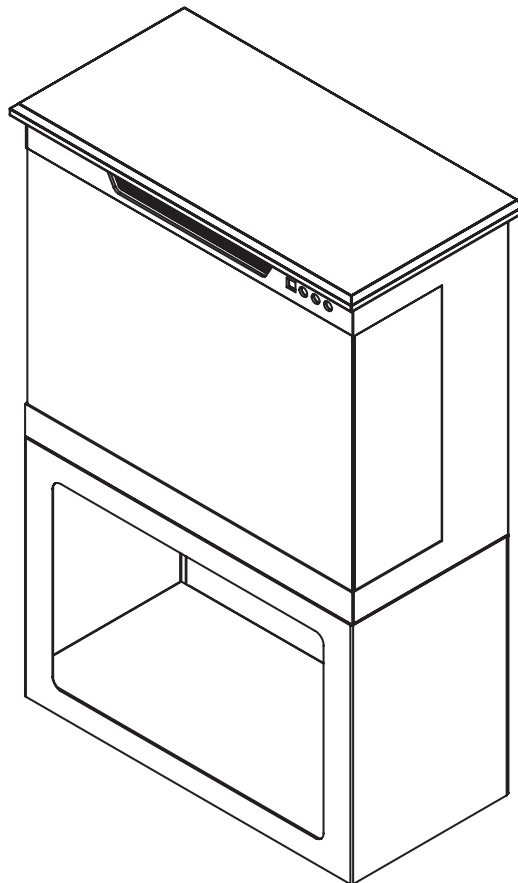

Model: EF-CON24-BS

## OWNER'S MANUAL

# Parts

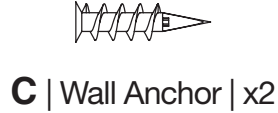

# Tools

(NOT INCLUDED)

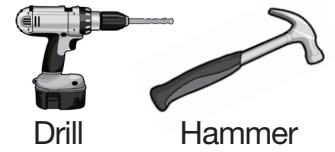

# Installation & Assembly

1. Remove Stove Screw (F) from the back of the stove.
2. Attach Safety Bracket (E) using Stove Screw (F).

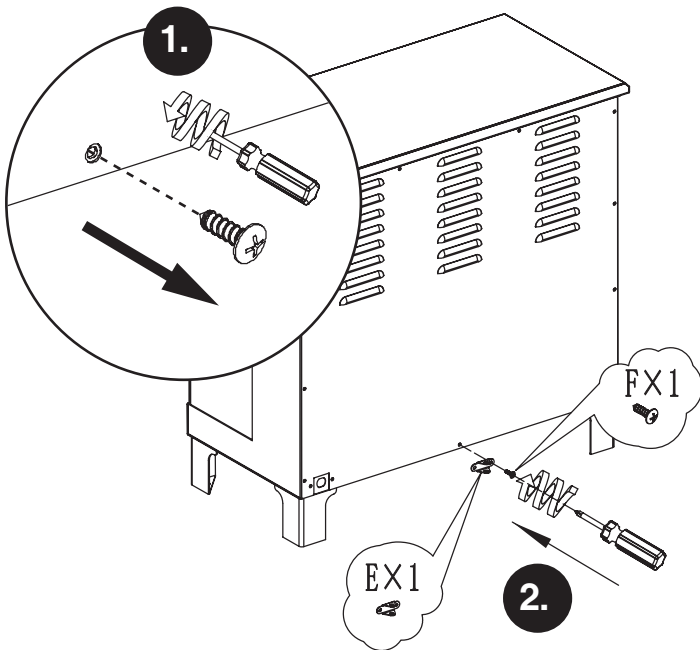

3. Place the Stove into the 3-Sided Stove Base. Press down on all 4 corners to ensure the stove is secure.

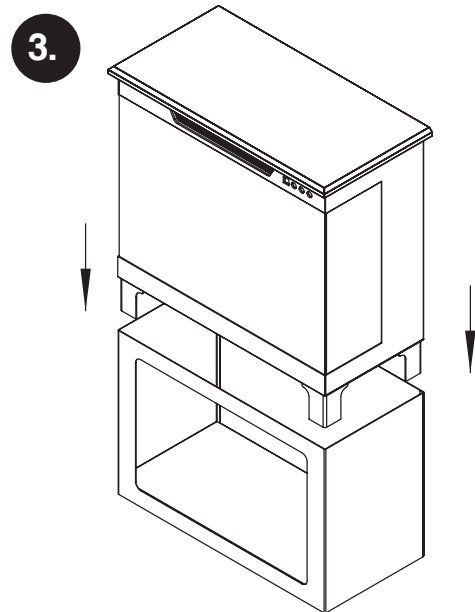

4. Thread Safety Strap (D) through back of Stove's Safety Bracket and remaining Safety Bracket (E). Use Safety Bracket to mark hole locations and drill pilot holes. Insert Wall Anchors (C). Secure remaining Safety Bracket (E) to wall using Wall Screws (B).

5. Place Safety Strap (D) between wall and stove Safety Brackets (E) and tighten Safety Strap (D).

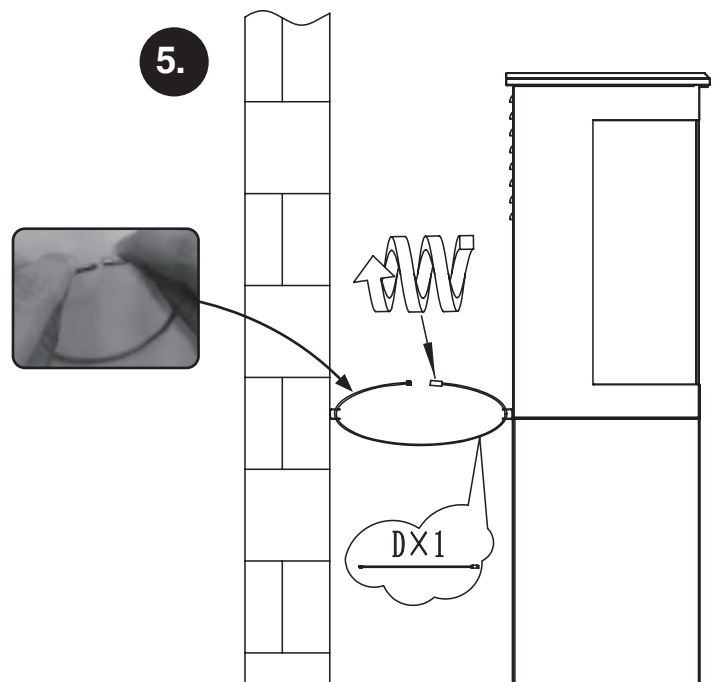

## NOTE:

Anchor is not necessary if screw is going into a stud.